

**ARACHNID, INC.**  
12" Monochrome Monitor  
Model # SB31-8U/V

## SERVICE MANUAL

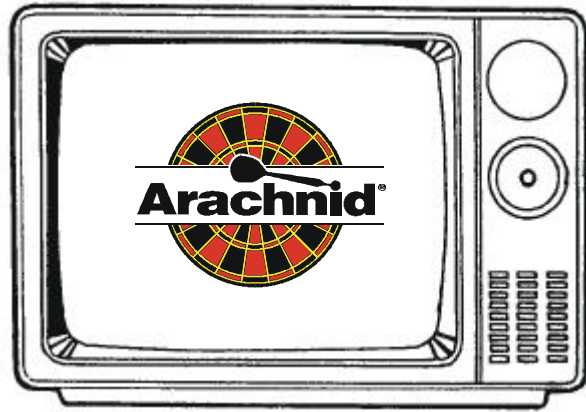

# Contents

<b>SAFETY PRECAUTIONS</b> .....	<b>2</b>
<b>FEATURES</b> .....	<b>3</b>
<b>LOCATION OF CONTROLS</b> .....	<b>3</b>
<b>GENERAL INFORMATION</b> .....	<b>4</b>
<b>Figure 5, P.C. Board, Component Side</b> .....	<b>5</b>
<b>Figure 6, P.C. Board, Solder Side</b> .....	<b>6</b>
<b>Figure 7, P.C. Board Copper, Solder Side</b> .....	<b>7</b>
<b>Figure 8, Schematic Diagram</b> .....	<b>8</b>
<b>Figure 9, Power Supply Schematic</b> .....	<b>9</b>
<b>PARTS LIST</b> .....	<b>10</b>

## **CAUTION**

**Before servicing the chassis, read the "Safety Precautions" section in this manual.**

# PREFACE

## SAFETY PRECAUTIONS

Operation of the monitor outside of its cabinet or with its back removed introduces a shock hazard. Service should only be performed by those who are thoroughly familiar with the precautions necessary when working on high voltage equipment.

Exercise care when servicing this chassis with power applied. Many voltage and video input terminals are exposed which, if carelessly contacted, can cause serious shock or result in damage to the chassis. Maintain interconnecting earth ground between the chassis, picture tube (CRT) dag, and PCB ground when operating the chassis.

Certain High Voltage failures can increase X-ray radiation. The monitor should not be operated with HV levels exceeding the specified rating for their chassis type. The maximum operating HV specified for the chassis used in these receivers is 12KV +1 and -2KV at zero beam current with a line voltage of 120VAC. Higher voltage may also increase the possibility of failure in the HV supply.

It is important to maintain specified values of all components in the horizontal and HV circuits and anywhere else in the monitor that could cause a rise in HV or operating supply voltages. No changes should be made to the original design of the monitor.

To determine the presence of high voltage, use an accurate high impedance, HV meter connected between the second anode lead and the CRT dag grounding device. When servicing the High Voltage System, remove static charge by connecting a 10K ohm resistor in series with an insulated wire (such as a test probe) between the CRT dag and the 2nd anode lead. Do this BEFORE disconnecting the AC line cord from the AC receptacle.

The picture tube used in this monitor employs integral implosion protection. Replace with a tube of the same type number for continued safety. Do not lift picture tube by the neck. Handle the picture tube only when wearing shatter-proof goggles and after discharging the high voltages completely. Keep others without shatter-proof goggles away.

## SAFETY INSPECTION

1. Inspect all wire harness assemblies to make sure that the wires are not pinched or that nothing is lodged between the chassis and other metal parts.
2. Replace all protective devices such as non-metallic control knobs, insulating fishpapers, cabinet backs, adjustment and compartment covers or shields, isolation resistor-capacity networks, mechanical insulators, etc.
3. To be sure that no shock hazard exists, a check for the presence of leakage current should be made at each exposed metal part connected to the chassis, such as cabinet metal, screw heads, knobs and/or shafts, etc. as follows:
  - a. Plug the AC line cord into a 12VAC receptacle. (Do not use an isolation transformer during these checks.) All checks must be repeated with the AC line cord plug connections reversed. (A non-polarized adaptor plug may be used only for the purpose of these tests.)
  - b. Measure the current using an accurate leakage current tester, if available. (We recommend Standard Equipment Item # 21641.) Any reading of 0.46A or more is excessive and indicates a potential shock hazard which must be corrected.
  - c. If a reliable leakage current tester is not available, and alternate method of measurement should be used. Using two clip leads, connect a 1.5K ohm, 10 watt resistor in parallel with a 0.15uf capacitor; all in series with a known earth ground. Use a VTVM or VOM with 1000 ohms per volt or higher sensitivity to measure the AC drop across the resistor. Any reading of 0.35V RMS or more is excessive and indicates a potential shock hazard which must be corrected.

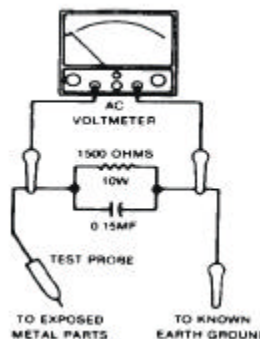

Figure 1, Voltmeter hookup for safety check

# FEATURES

2000 display characters in a 8 x 8 dot format.  
18 MHz bandwidth, medium class, composite signal input.  
**PLEASE NOTE:** This monitor does not emit any sound.

# LOCATION OF CONTROLS

This monochrome monitor uses an RCA jack connector for the input signal.  
The input signal is composite video based.

Figure 2 shows the monitor controls on the front and rear panels:

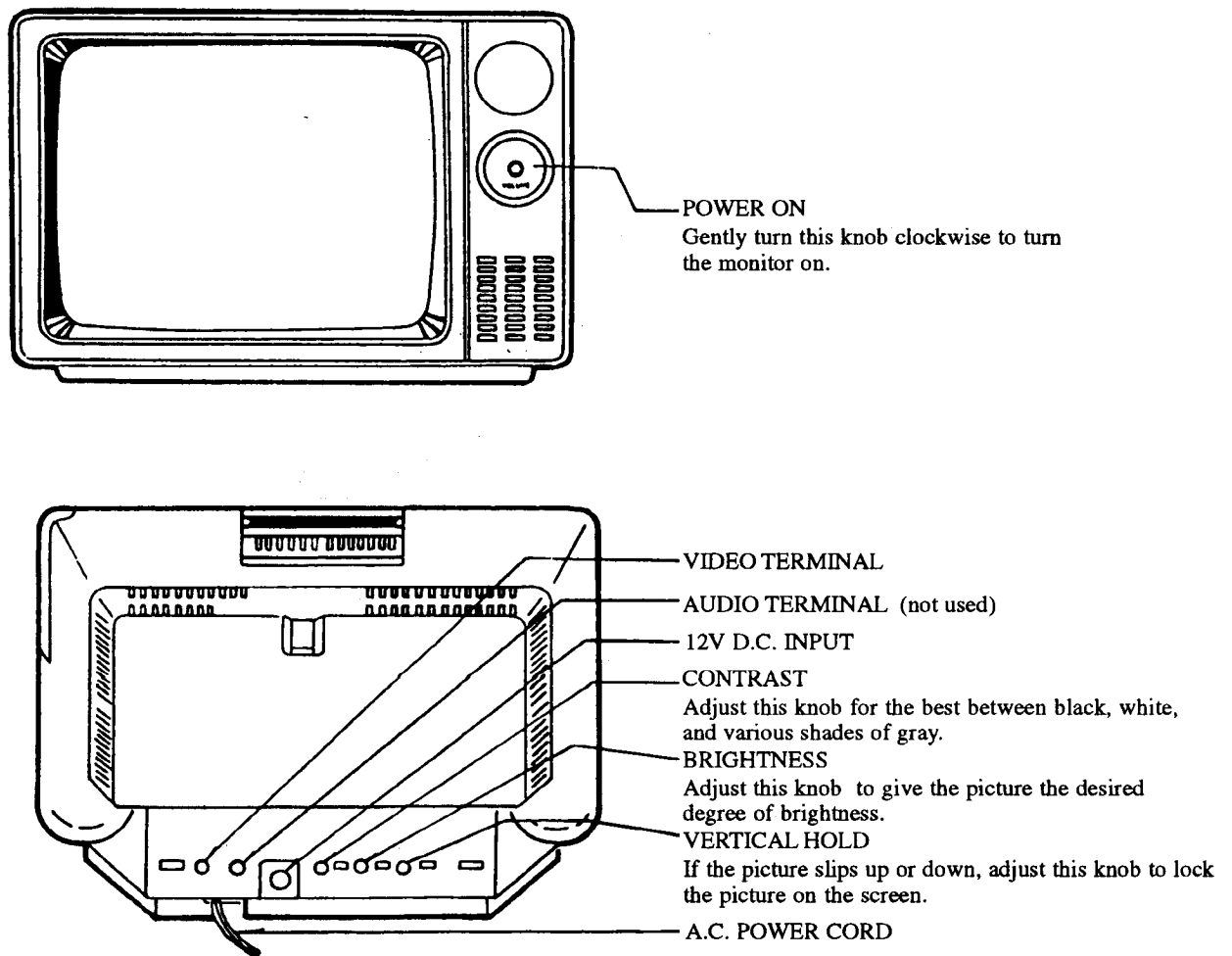

Figure 2, Monitor Controls

# GENERAL INFORMATION

## FOR BEST RESULTS...

1. Avoid excessively warm locations. Never place your monitor or dart game on or near a radiator or any similar source of heat.
2. Avoid placing your monitor or dart game in direct bright light, as the glare produced on the screen may impair viewing.



**VERTICAL LOCK**  
If picture moves up or down, adjust VERTICAL HOLD by moving knob right, then left, until image locks in screen.

Figure 3



**AUTO IGNITION**  
... or nearby electrical driven appliances can cause small streaks or speckles across picture or make picture roll.

Figure 4



## GRAPHICAL SYMBOLS EXPLANATION



The lightning flash with arrowhead symbol, within an equilateral triangle, is intended to alert the user to the presence of uninsulated "dangerous voltage" within the product's enclosure that may be of sufficient magnitude to constitute a risk of electric shock to persons

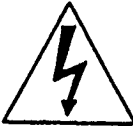

The exclamation point within an equilateral triangle is intended to alert the user to the presence of important operating and maintenance (servicing) instructions in the literature accompanying the appliance.

	<b>CAUTION</b> RISK OF ELECTRIC SHOCK DO NOT OPEN	
<p>CAUTION : TO REDUCE THE RISK OF ELECTRIC SHOCK.</p> <p>DO NOT REMOVE COVER (OR BACK).</p> <p>NO USER-SERVICEABLE PARTS INSIDE.</p> <p>REFER SERVICING TO QUALIFIED SERVICE PERSONNEL.</p>		

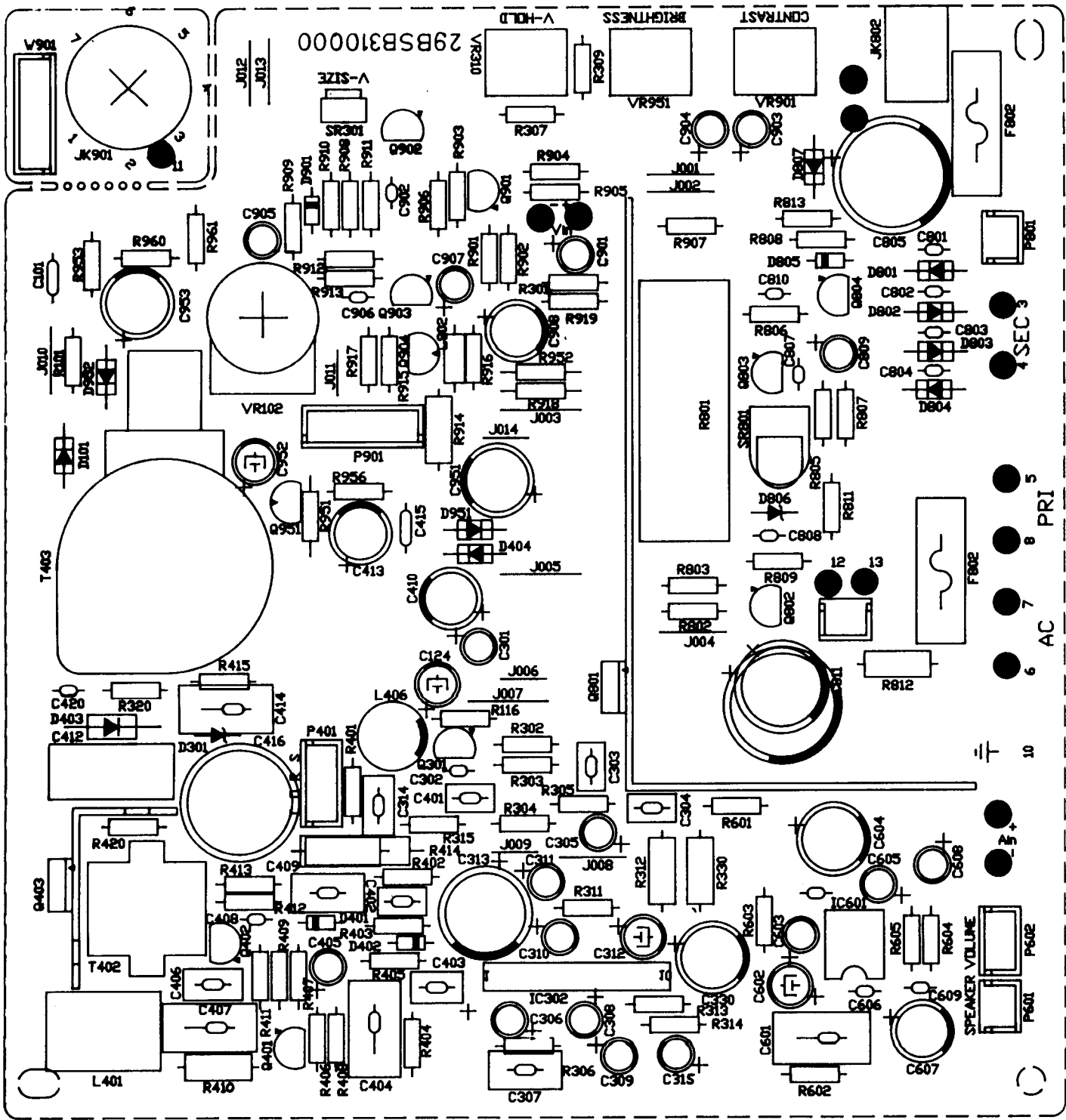

Figure 5, P.C. Board, Component Side



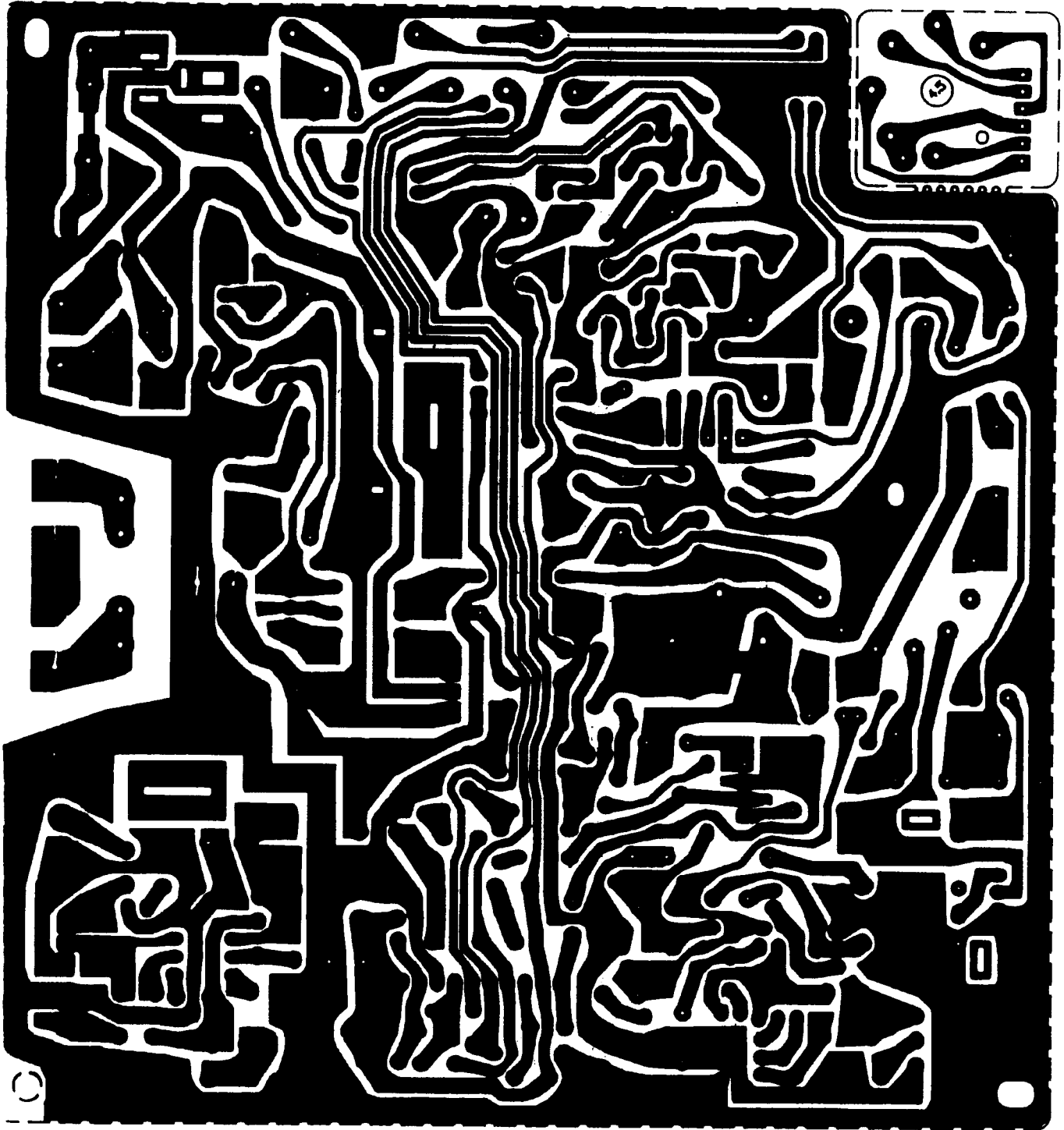

Figure 7, P.C. Board Copper, Solder Side



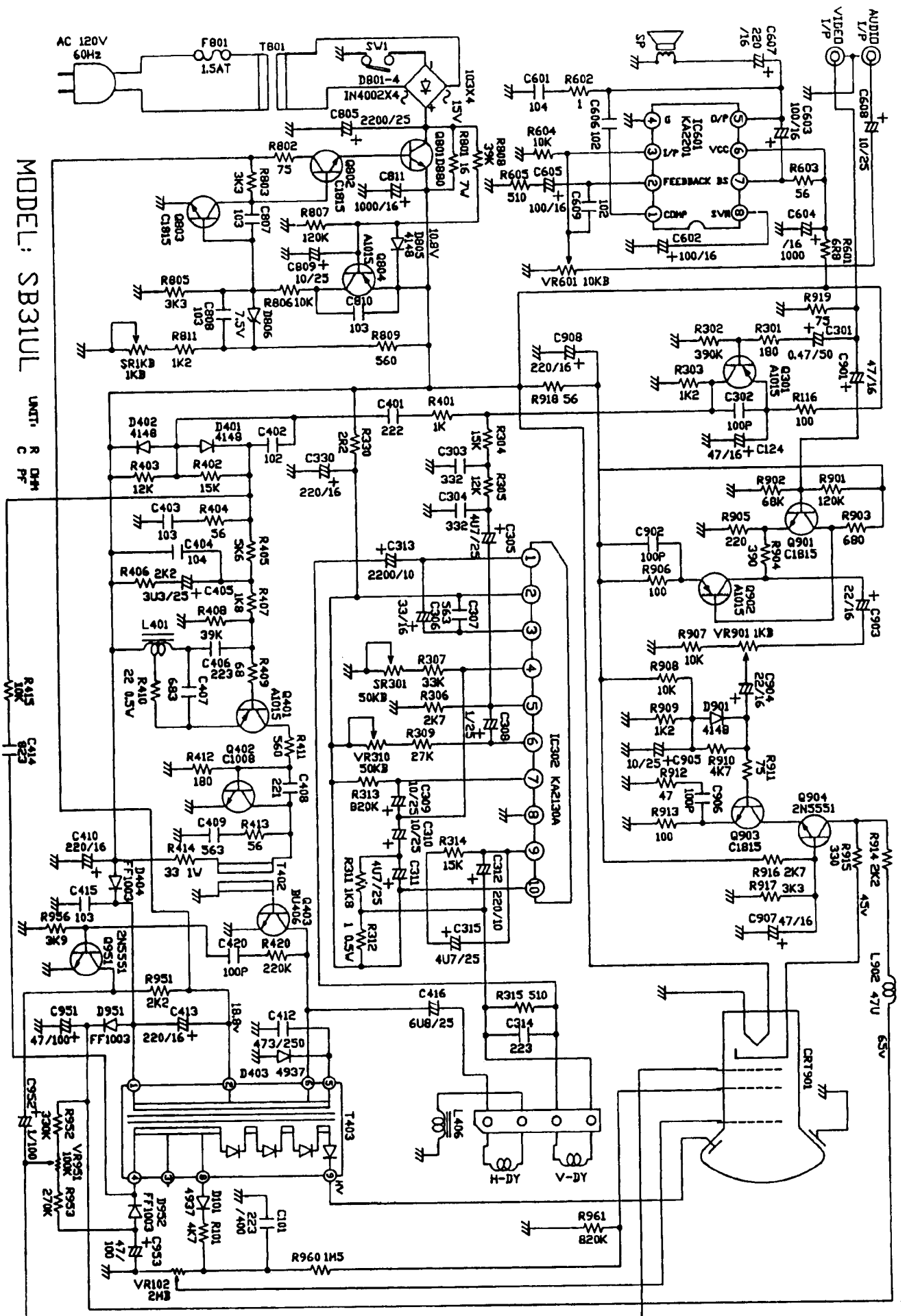

Figure 8 Schematic Diagram



# PARTS LIST

DESCRIPTION	LOCATION(S)	* ARACHNID PART #
RES 1/4W 5% 1 OHM	R602	
RES 1/4W 5% 2.2 OHM	R330	
RES 1/4W 5% 6.8 OHM	R601	
RES 1/4W 5% 47 OHM	R912	
RES 1/4W 5% 56 OHM	R404, R413, R603, R918	
RES 1/4W 5% 68 OHM	R409	
RES 1/4W 5% 75 OHM	R802, R911, R919	
RES 1/4W 5% 100 OHM	R116, R906, R913	
RES 1/4W 5% 180 OHM	R301, R412	
RES 1/4W 5% 220 OHM	R905	
RES 1/4W 5% 330 OHM	R915	
RES 1/4W 5% 390 OHM	R904	
RES 1/4W 5% 510 OHM	R315, R605	
RES 1/4W 5% 560 OHM	R411, R809	
RES 1/4W 5% 680 OHM	R903	
RES 1/4W 5% 1K	R401	
RES 1/4W 5% 1.2K	R303, R811, R909	
RES 1/4W 5% 1.8K	R311, R407	
RES 1/4W 5% 2.2K	R406, R914, R951	
RES 1/4W 5% 2.7K	R306, R916	
RES 1/4W 5% 3.3K	R803, R805, R917	
RES 1/4W 5% 3.9K	R956	
RES 1/4W 5% 4.7K	R101, R910	
RES 1/4W 5% 5.6K	R405	
RES 1/4W 5% 10K	R415, 604, 806, 907, 908	
RES 1/4W 5% 12K	R305, R403	
RES 1/4W 5% 15K	R304, R402, R314	
RES 1/4W 5% 27K	R309	
RES 1/4W 5% 33K	R307	
RES 1/4W 5% 39K	R408, R808	
RES 1/4W 5% 68K	R902	
RES 1/4W 5% 120K	R807, R901	
RES 1/4W 5% 220K	R420	
RES 1/4W 5% 270K	R953	
RES 1/4W 5% 330K	R952	
RES 1/4W 5% 390K	R302	
RES 1/4W 5% 820K	R313, R961	
RES 1/4W 5% 1M	R812	
RES 1/4W 5% 1.5M	R960	
RES 1/2W 5% 1 OHM	R312	
RES 1/2W 5% 22 OHM	R410	
RES 1W 33 OHM	R414	
RES 7W 16 OHM	R801	
RES 1/4W 1K VAR	SR801, VR901(contrast)	39539
RES 1/5W 100K VAR	VR951(brightness)	
RES 1/5W 50K VAR	SR301(vert. height), VR310(vert. hold)	39541
RES 1/4W 2M VAR	VR102(focus)	39542
RES 1/4W 10K VAR	VR601(on/off)	

## PARTS LIST cont'd

DESCRIPTION	LOCATION(S)	* ARACHNID PART #
CAP 220uF 10V	C312	
CAP 2200uF 10V	C313	
CAP 22uF 16V	C903, C904	
CAP 33uF 16V	C306	
CAP 47uF 16V	C124, C901, C907	
CAP 100uF 16V	C602, C603, C605	
CAP 220uF 16V	C330, C410, C413, C607, C908	
CAP 1000uF 16V	C604, C811	
CAP 6.8uF 50V NP HF	C416	40857
CAP 10uF 25V	C309, C310, C608, C809, C905	
CAP 2200uF 25V	C805	
CAP 1uF 25V	C308	
CAP 3.3uF 25V	C405	
CAP 4.7uF 25V	C311, C305, C813	
CAP 100pF 50V	C302, C420, C902, C906	
CAP 220pF 50V	C408	
CAP 1000pF 50V	C402, C606, C609	
CAP 0.01uF 50V	C801, C802, C803, C804, C807, C808, C810	
CAP 0.47uF 50V	C301	
CAP 2200pF 50V	C401	
CAP 3300pF 50V	C303, C304	
CAP 0.01uF 50V	C403	
CAP 0.022uF 50V	C314, C406	
CAP 0.056uF 50V	C307, C409	
CAP 0.068uF 50V	C407	
CAP 0.082uF 50V	C414	
CAP 0.1uF 50V	C601, C404	
CAP 1uF 100V	C952	
CAP 47uF 100V	C951, C953	
CAP 0.047uF 250V	C412	
CAP 0.022uF 400V	C101	
CAP 0.01uF 500V	C415	
TRANS 3DG1008 or 2SC1815G	Q802, Q803, Q901, Q903	39544
TRANS 2SA1015	Q401, Q301, Q804, Q902	
TRANS 3DX201B or 2SC1008	Q402	39545
TRANS BU406 or 2SC2233	Q403	39546
TRANS 3DD880 or 2SD880Y	Q801	
TRANS 2N5551Y	Q904, Q951	
I.C. KA2130A	IC302	39547
I.C. KA2201	IC601	39548
IND KLN1023	L401	
IND 47uH	L902	
IND 12.5uH	L406	

## PARTS LIST cont'd

DESCRIPTION	LOCATION(S)	* ARACHNID PART #
DIODE 1N4002	D801, 802, 803, 804	
DIODE FF1003	D951, D952	
DIODE 1N4148	D401, D402, D805, D901	
DIODE 1N4937	D101, D403, D404	
DIODE ZENER MTZ7.5VB	D806	39549
H. DRIVE KLN516A	T402	
FBT BSH11-N03LB	T403	39550
POWER XFORMR 120V/12V (22WT003)	T801	39551
FUSE 250V @ 1.5A	F001	
DEFLECTING YOKE QPH20-90-1203A		39552
CRT		39553
MAIN P.C. BOARD		39554
CRT P.C. BOARD		39555
MONITOR, COMPLETE		39078

\* Availability of these components from Arachnid is dependant upon manufacturer's availability and customer demand.



6421 Material Ave. Rockford, IL 61111 815-654-0212 800-435-8319 FAX 815-654-0447

P.N. 39354 REV A